

STRETCHER TROLLEY





Our primary objective is your **satisfaction**. Our **requirements** are as exacting as we would expect as a customer.

By supporting you from defining the product and throughout its life, we guarantee **high-performance** products, and a **responsive** and **high-quality service**.

We try, with humility, to **understand** your **use**, your **constraints** and to redefine the circuit of your patients to **improve** your **working conditions** and the **efficiency** of your **organization**.

We base our relationships on **shared trust**, making it our priority to be by your side for the **long term**.

UNDERSTAND YOUR USE, YOUR CONSTRAINTS

Bi-lateral variable height

Its high-quality hydraulic columns can withstand over 30,000 cycles. Its long lever arm reduces pushing effort: real comfort for staff.

Hygienic mattress

Velcro-free, cleaning the mattress and hard surface is easy. The cover is resistant to decontaminants and the zipper is protected from liquids. From 8 to 15 cm (3 to 6 inches), it offers the patients comfort, even over a long period.

Retractable handles

Their ergonomic shape make pushing easy and comfortable. Made from ultra-resistant plastic, they don't rust.

Resistant barriers

Equipped with two rotation axes, they are 10 times more resistant than the standard. The side button positioned on the foot side is easily positioned for staff while remaining inaccessible to patients. They can be retracted under the sleeping surface, making transfers easy.

Reinforced wheels

Each wheel supports a load of 220kg (485 lbs). The thick tire absorbs shocks and the rolling noise. They are waterproof as well as dust-proof. Compatible with all types of flooring, including tarmac.

Corner protections

Its shape was specially studied to absorb impacts. Highly resistant, the part can also be removed and recycled. Three colors are available to differentiate stretchers between departments.

5th directional wheel

Intuitive and easy to guide, the fifth wheel considerably reduces staff pushing efforts. Regardless of the weight, the stretcher is light and easy to handle.

Lowering, Trendelenburg and Reverse Trendelenburg positions

Positions are operated with the foot, on each side of the stretcher: easy to access, even with sterile, dirty or occupied hands. The pedals are placed ergonomically, at an easy height for each user.



M O B I L I T Y

Our stretchers have been designed to make your daily life easier



We understand that your time is precious. Each second counts. That is why our stretcher is so easy to use. Its fifth directional wheel makes it light and intuitive. Controlled by the same pedal as the other wheels, it can be set up without even having to think about it. Its reinforced wheels can adapt to any type of floor or obstacle. Its push bars perfectly fit the shape of your hands. Improving your working conditions is one of our priorities.

Guaranteeing the **safety** of your patients



Patient safety is not optional. The stability of our product is such that even when placed in the least favorable conditions, the stretcher does not tip over. In an emergency, the Trendelenburg or Reverse Trendelenburg or CPR (cardiopulmonary resuscitation) positions can be reached within seconds.

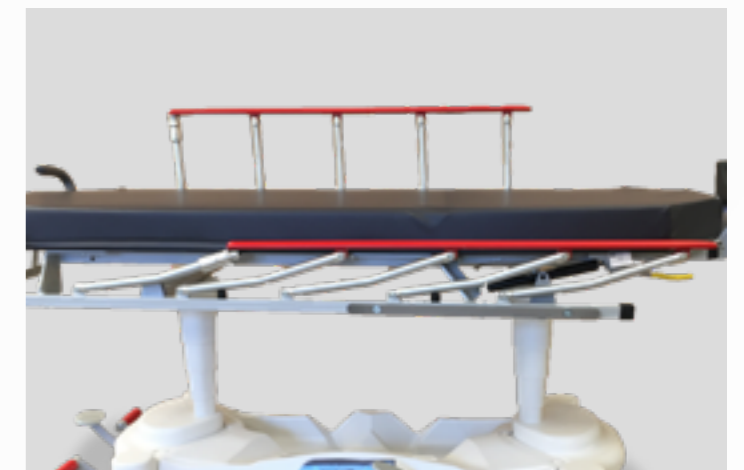

R E L I A B I L I T Y

High-quality components,
Long-term use,
A reduced environmental footprint

Our environmental awareness has led us towards an eco-friendly design. BMB MEDICAL is concerned about the ecological impact of its products at each stage of their life cycle. This commitment is reflected in actions in relation to packaging, the “4R” policy (reduce, replace, recycle, recover) and work on materials. Our products are designed in accordance with standard IEC60601-1-9, that defines the requirements for **eco-friendly design**.



Our products are tested on a testing bank with constraints that are significantly higher than those it will be subjected to in daily use. Our columns require no maintenance. Our sleeping surfaces are made from compact laminate, an extremely resistant and rot-proof material. Our corner protections are resistant to shocks and aging. Our barriers with two rotation axes are particularly robust. Choosing BMB MEDICAL is a guarantee of quality but also offers significant savings on your maintenance budget.

C O N T E N T S

C A R E O

C A R U I

C A R U I K I D S

I - C A R E A M B U L A T O R Y

I - C A R E E M E R G E N C Y

I - C A R E O P H T A L M O L O G Y

I - C A R E M O T O R I S E D

P R E L E



HEIGHT-ADJUSTABLE STRETCHER TROLLEY CAREO

Comfortable

Adaptable many options available

Easy to use, variable height & trendelenburg

Versatile, adapted to different hospital services

CAREO is a patient trolley with height adjustment on hydraulic columns.

Easy to use and robust, CAREO is the perfect product for patient transportation.

Equipped with radio translucent material, adjustable back rest, Trendelenburg/Antitrendelenburg, CAREO is also suitable for emergency and operating rooms.



CAREO DIMENSIONS

	LENGTH	WIDTH
OVERALL	201 cm	74 cm
VARIABLE HEIGHT	64 - 97 cm (including 8cm thick mattress)	

PRODUCT WEIGHT : 80 Kg
SAFE WORKING LOAD : 200 Kg



NON CONTRACTUAL PHOTOS - ACCESSORIZED PRODUCTS

Combining lightness, robustness and intuitiveness, our STRETCHER TROLLEY range is suitable for patient transfer, emergencies and recovery room. On request, many options allow a perfect match to your needs.

Height-adjustable trolley stretcher

- Removable mattress made of high quality and resilience foam (35kg/m³) - Height : 8 cm
- Trendelenburg / Anti-Trendelenburg +/-18°, hands free control
- Backrest adjustable by 2 gas springs (0 - 90°)
- Thermoformed ABS base
- 2 holders for IV pole head-end
- Bumpers on all 4 corners
- Castors Ø 200 mm with central steering and braking system foot-end
- 2 directional wheels head-end
- Drop-down side rails with 2 horizontal bars - Anodized aluminium.
- Fixed push bar foot-end
- Frame cover including O₂ tank holder
- Removable cover - PVC coated Jersey - Colour : grey

2 holders for IV pole head-end



Removable mattress made of high quality and resilience foam (35kg/m³), thickness: 8 cm



Castors Ø 200 mm with central steering and braking system foot-end



Drop-down side rails, 2 horizontal bars. Anodized aluminium



Frame cover including O₂ tank holder



Bumpers on all 4 corners

ACCESSORIES

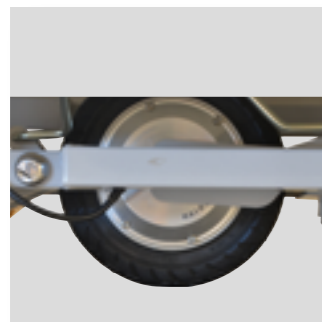

5th directional wheel
CRO5E

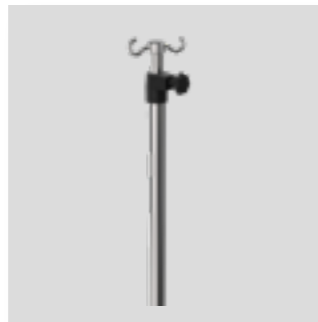

Removable IV pole, 2-stage, 2 hooks
TSR2



Foldable push bars foot-end
BPP



Foldable push bars head-end
BPT



Vertical oxygen bottle holder
CROSO2



Paper roll dispenser at the head-end
CROSP



Chart holder (for paperwork) below the headrest
CRODOC



Attachment hooks for bags on both sides below the patient surface
PSU

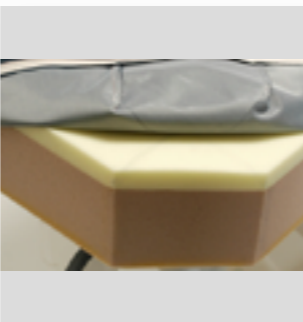

Comfort mattress
CEOMM

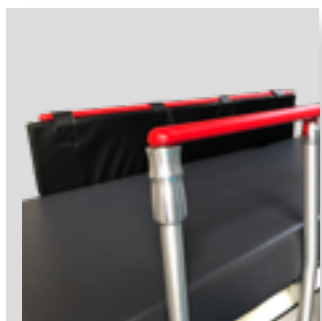

Side rail padded cushions (pair)
CROPB



Universal Meal tray
Extensible meal tray for side rails:
from 65 to 88 cm
Fall protection side
Compatible with standardized tray meal :
GastroNorm – GN1/1 : 53 x 32.5 cm
EuroNorm : 53 x 37 cm
It fits with all width of products.
Maximum load: 10Kg
PRU

REFERENCE	DESIGNATION
CRO5E	5th directional wheel
TSR2	Removable 2-stage IV pole, 2 hooks
TSR4	Removable IV pole, 2-stage, 4 hooks
BPP	Foldable push bars foot-end
BPT	Foldable push bars head-end
CROSO2	Vertical oxygen bottle holder
CROSP	Paper roll dispenser at the head-end
CRODOC	Chart holder (for paperwork) below the headrest
PSU	Attachment hooks for bags on both sides below the patient surface
CEOMM	Comfort mattress for CAREO
CROPB	Side rail padded cushions (pair)
PRU	Universal Meal tray Extensible meal tray for side rails: from 65 to 88 cm Fall protection side



HEIGHT-ADJUSTABLE STRETCHER TROLLEY CARVI

Comfortable

Adaptable many options available

Easy to use, variable height & trendelenburg

Versatile, adapted to different hospital services

CARVI is a patient trolley with height adjustment on hydraulic columns.

Light, robust, and user-friendly, it is designed for patient transportation, emergency and PACU settings.

Various optional features are available to meet all your needs.



CARVI DIMENSIONS

	LENGTH	WIDTH
OVERALL	216 cm	68 / 78 / 88 cm
VARIABLE HEIGHT	65 - 98 cm (including 8cm thick mattress)	

PRODUCT WEIGHT : 90 Kg / 94 Kg / 98 Kg (depending on model)
SAFE WORKING LOAD : 250 Kg



NON CONTRACTUAL PHOTOS - ACCESSORIZED PRODUCTS

Combining lightness, robustness and intuitiveness, our STRETCHER TROLLEY range is suitable for patient transfer, emergencies and recovery room. On request, many options allow a perfect match to your needs.

Height-adjustable stretcher trolley

- Removable mattress made of high quality and resilience foam (35kg/m³) - Height : 8 cm
- Trendelenburg / Anti-Trendelenburg +/-18°, hands free control
- Backrest adjustable by 2 gas springs (0 - 90°)
- Thermoformed ABS base
- 2 holders for IV pole head-end
- Bumpers on all 4 corners
- Castors Ø 200 mm with central steering and braking system foot-end
- 2 directional wheels head-end
- Drop-down side rails with 2 horizontal bars - Anodized aluminium.
- Fixed push bar foot-end
- Frame cover including O2 tank holder
- Removable cover - PVC coated Jersey - Colour : grey

6 holders for IV pole



Removable mattress made of high quality and resilience foam (35kg/m³), thickness: 8 cm

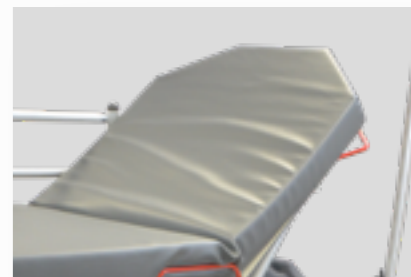

Castors with central braking system
Ø 200 mm at foot-end



Foldable push bars at the foot-end 2 parts



Frame cover including utility tray
and O2 tank holder



Bumpers on all 4 corners

ACCESSORIES

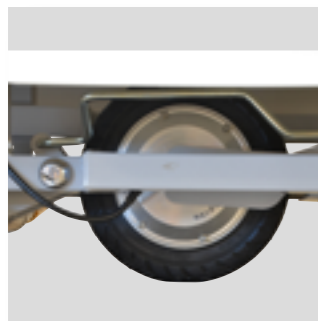

5th directional wheel
CRO5E



Reinforced castors (CRO5E necessary)
CRORR



Anti-static system
CLORA



Side rails 3 horizontal bars
CROB3B



Bed panel instead of push bars
MLOPL



Tige porte serum
TSR2



Foldable push bars head-end
CROBPT



Foldable push bar
foot-end 1 part
CROBPP1



X-ray cassette below the patient surface
(incompatible with CORBE + CRORJ + CORJE)
CROK7



Electric backrest with
manual release
CORBE



Knee gatch & Electric backrest
and knee gatch, manual release
CRORJ & CORJE



Patient's remote control
COTLC

REFERENCE	DESIGNATION
CRO5E	5th directional wheel
CRORR	Reinforced castors (CRO5E necessary)
CLORA	Anti-static system
CROB3B	Side rails 3 horizontal bars
MLOPL	Bed panel instead of push bars
TSE2C	Permanent, foldable 3-stage "comfort" IV pole, 2 hooks
TSE4C	Permanent, foldable 3-stage "comfort" IV pole, 4 hooks
TSR2	Removable 2-stage IV pole, 2 hooks
TSR4	Removable IV pole, 2-stage, 4 hooks
CROBPT	Foldable push bars head-end
CROBPP1	Foldable push bar foot-end 1 part
CROK7	X-ray cassette below the patient surface (double hard surface) (incompatible avec CORBE + CRORJ + CORJE)
CORBE	Electric backrest with manual release
CORJE	Electric backrest and knee gatch, manual release
COBBA	Battery
COTLC	Patient's remote control
CRORJ	Knee gatch
CROSO2	Oxygen bottle holder
CROSP	Paper roll dispenser at the head-end
CRODOC	Chart holder (for paperwork) below the headrest
PSU	Attachment hooks for bags on both sides below the patient surface
CROPSC	Monitor tray at the foot-end. 2 locations available (1 tray in width 60cm / 1 or 2 trays in width 70 and 80 cm)
MC	Comfort mattress, high quality foam (35 kg/m3), height : 10 cm
MMC	High Comfort mattress, high quality foam (35 kg/m3) + 2 cm thick viscoelastic layer (total height : 12 cm)
EQUI	Equipotential connection
CRORT	Rail DIN
ETU	Fixation clamp for armrest (on rail DIN, CRORT necessary)

ACCESSORIES

REFERENCE	DESIGNATION
ETU-R	Adjustable fixation clamp for armrest (on rail DIN, CRORT necessary)
GT	Anatomic shaped armrest (ETU-R necessary)
CROPB	Side rail padded cushions (pair)
PRU	Universal Meal tray Extensible meal tray for side rails: from 65 to 88 cm Fall protection side



Vertical oxygen bottle holder
CROSO2

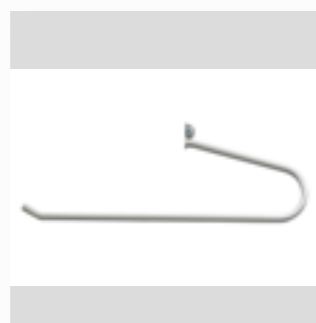

Paper roll dispenser at the head-end
CROSP



Chart holder (for paperwork)
below the headrest
CRODOC



Attachment hooks for bags on both
sides below the patient surface
PSU



Monitor tray at the foot-end
CROPSC



Comfort mattress
MC & MMC

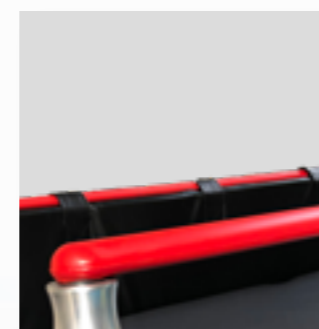

Side rail padded cushions (pair)
CROPB





HEIGHT-ADJUSTABLE STRETCHER TROLLEY **CARUI KIDS**

Comfortable

Adaptable many options available

Easy to use, variable height & trendelenburg

Versatile, adapted to different hospital pediatrics services



CARVI is a patient trolley with height adjustment on hydraulic columns.

CARVI KIDS complies, with its specific side rails and paediatric kit at head-end, with the requirements

from April, 26th 2010 of the French Medical Safety Agency ANSM with regard to children under 146 cm.

CARVI KIDS is designed to provide absolute safety while transporting children.

Light, robust, and user-friendly, it is designed for patient transportation, emergency and PACU settings. Various optional features are available to meet all your needs.

CARUI KIDS

CARUI KIDS DIMENSIONS

	LENGTH	WIDTH
OVERALL	199 cm	73 cm
VARIABLE HEIGHT	65 - 98 cm cm (including 8 cm thick mattress)	

PRODUCT WEIGHT : 85 Kg
SAFE WORKING LOAD : 250 Kg

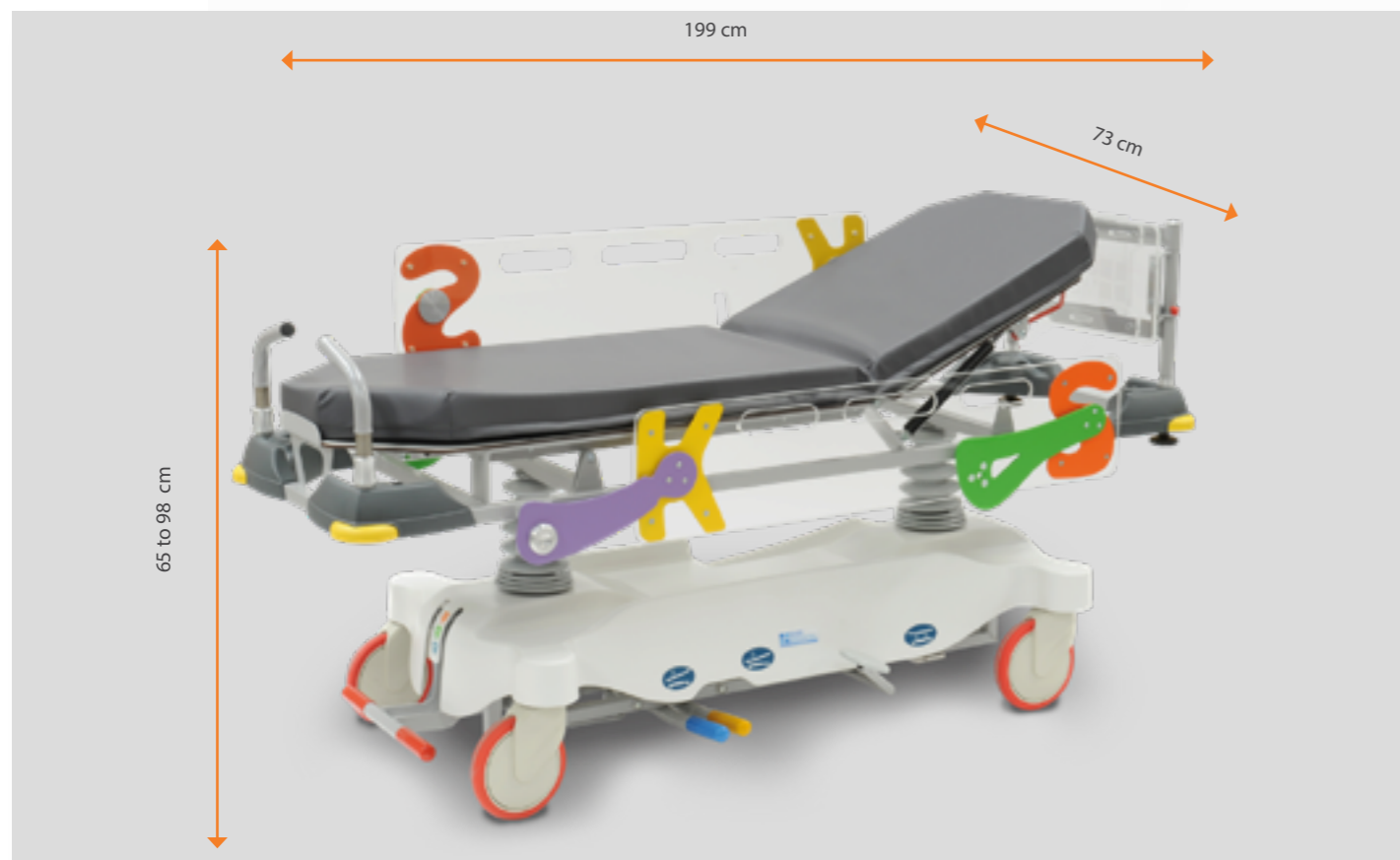

NON CONTRACTUAL PHOTOS - ACCESSORIZED PRODUCTS

Combining lightness, robustness and intuitiveness, our STRETCHER TROLLEY range is suitable for patient transfer, emergencies and recovery room. On request, many options allow a perfect match to your needs.

Height-adjustable pediatric stretcher trolley

- Height adjustment: from 57 to 90 cm (without 8 cm thick mattress)
- Trendelenburg / Anti-Trendelenburg +/- 18°
- Removable mattress made of high quality and resilience foam (35kg/m³) - Thickness : 8 cm
- Radiolucent material
- Two-sided height adjustment and Trendelenburg / Anti-Trendelenburg adjustment
- 6 holders for IV pole
- Bumpers on all 4 corners
- Backrest adjustable by 2 gas springs (0 - 90°)
- Castors with central braking system Ø 200 mm at foot-end
- 2 directional wheels at the head-end (without 5th directional wheel)
- * Drop-down side rails with 2 horizontal bars - Anodized aluminium
- Foldable push bars at the foot-end 2 parts
- Frame cover including utility tray and O2 tank holder
- Removable cover - PVC coated Jersey - Colour : grey

6 holders for IV pole



Removable mattress made of high quality and resilience foam (35kg/m³), height : 8 cm



Castors with central braking system Ø 200 mm at foot-end



Foldable push bars at the foot-end (2 parts)



Bumpers on all 4 corners

Frame cover including utility tray and O2 tank holder



ACCESSORIES

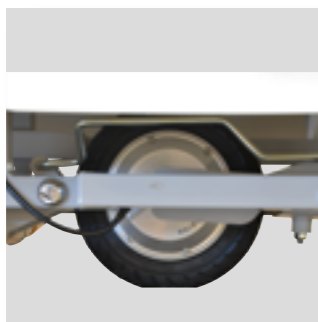

5th directional wheel
CRO5E



Anti-static system
CLORA



Side rails 3 horizontal bars
CROB3B



Bed panel instead of push bars
MLOPL



Polycarbonate paediatric side rails
CKOBP



Paediatric kit head-end
CKOKT

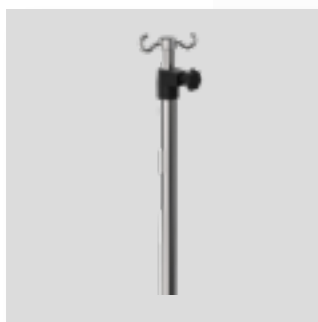

Removable IV pole, 2-stage, 2 hooks
TSR2



Foldable push bars head-end
(incompatible with CKOKT)
CROBPT



Foldable push bar foot-end 1 part
CROBPP1



Paper roll dispenser at the head-end
CROSP



Chart holder (for paperwork)
below the headrest
CRODOC



Attachment hooks for bags on both
sides below the patient surface
PSU

REFERENCE	DESIGNATION
CRO5E	5th directional wheel
CLORA	Anti-static system
CROB3B	Side rails 3 horizontal bars
MLOPL	Bed panel instead of push bars
CKOBP	Polycarbonate paediatric side rails
CKOKT	Paediatric kit head-end
TSE2C	Permanent, foldable 3-stage «comfort» IV pole, 2 hooks (incompatible with CKOKT)
TSE4C	Permanent, foldable 3-stage «comfort» IV pole, 4 hooks (incompatible with CKOKT)
TSR2	Removable IV pole, 2-stage, 2 hooks
TSR4	Removable IV pole, 2-stage, 4 hooks
CROBPT	Foldable push bars head-end (incompatible with CKOKT)
CROBPP1	Foldable push bar foot-end 1 part
CROSP	Paper roll dispenser at the head-end
CRODOC	Chart holder (for paperwork) below the headrest
PSU	Attachment hooks for bags on both sides below the patient surface
CROPSC	Monitor tray at the foot-end.
MC	Comfort mattress, high quality foam (35kg/m3) - Thickness 10cm
EQUI	Equipotential connection
CKOCL	Lateral protection cushion for paediatric side rails
CKOCT	Head protection cushion (CKOCL obligatory)
PRU	Universal Meal tray Extensible meal tray for side rails: from 65 to 88 cm Fall protection side



STRETCHER TROLLEY I-CARE AMBULATORY

Comfortable

Adaptable many options available

Easy to use, variable height & trendelenburg

Versatile, adapted to different hospital services

I-CARE is a patient trolley with height adjustment on hydraulic columns.

Stable and robust, it is ideally designed to an intensive use.

Its features and its wide range of accessories make it especially suitable for Emergency, OR, PACU or ASC settings.



I-CARE AMBULATORY

I-CARE AMBULATORY DIMENSIONS

	LENGTH	WIDTH
OVERALL	216 cm	68 / 78 / 88 cm
VARIABLE HEIGHT	68 - 101 cm (including 10 cm thick mattress)	

PRODUCT WEIGHT : 80 Kg / 85 Kg / 90 Kg (depending on model)
SAFE WORKING LOAD : 320 Kg



NON CONTRACTUAL PHOTOS - ACCESSORIZED PRODUCTS

Combining lightness, robustness and intuitiveness, our STRETCHER TROLLEY range is suitable for patient transfer, emergencies and recovery room.

On request, many options allow a perfect match to your needs.

Height-adjustable stretcher trolley

- Overall dimensions: 68 x 216 cm, 78 x 216 cm or 88 x 216 cm (depending on model)
- Height adjustment range : from 58 to 91 cm (without 10 cm thick mattress)
- Trendelenburg / Anti-Trendelenburg +/- 18°
- Backrest adjustable by 2 gas springs (0 - 90°)
- Removable mattress made of high quality and resilience foam (35kg/m³) - Thickness : 10 cm
- Radiolucent material
- Two-sided + foot or head-end height adjustment and Trendelenburg / Anti-Trendelenburg adjustment
- 6 holders for IV pole
- Bumpers on all 4 corners
- Castors with central braking system Ø 200 mm at foot- and head-end
- 5th retractable directional wheel
- Drop-down side rails with 3 horizontal bars - Anodized aluminium
- Foldable push bars at the foot-end 2 parts
- Frame cover (removable for easy cleaning and maintenance) including utility tray and O2 tank holder
- Removable cover - PVC coated Jersey - Colour : grey

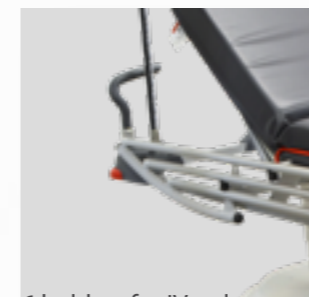

6 holders for IV pole



Castors with central braking system Ø 200 mm at foot-end and head-end

Removable mattress made of high quality and resilience foam (35kg/m³), thickness: 10 cm



Foldable push bars at the foot-end 2 parts

Frame cover (removable for easy cleaning and maintenance) including utility tray and O2 tank holder



Two-sided + foot or head-end height adjustment and Trendelenburg/ Anti-Trendelenburg adjustment

ACCESSORIES



Anti-static system
CLORA

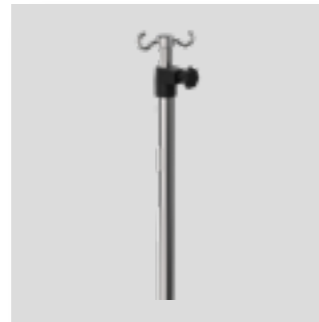

Removable 2-stage IV pole, 2 hooks
TSR2



Foldable push bars head-end
CROBPT



Foldable push bar foot-end 1 part
CROBPP1



X-ray cassette below the patient surface
(incompatible with CORBE + CRORJ + CORJE)
CROK7



Electric backrest with
manual release
CORBE



Knee gatch & Electric backrest and
knee gatch, manual release
CRORJ & CORJE



Patient's remote control
COTLC



Vertical oxygen bottle
holder
CROSO2

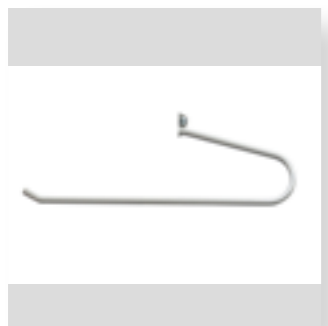

Paper roll dispenser at the head-end
CROSP



Chart holder (for paperwork)
below the headrest
CRODOC



Attachment hooks for bags on
both sides below the patient
surface
PSU

REFERENCE	DESIGNATION
CLORA	Antistatic system
TSE2C	Permanent, foldable 3-stage "comfort" IV pole, 2 hooks
TSE4C	Permanent, foldable 3-stage "comfort" IV pole, 4 hooks
TSR2	Removable 2-stage IV pole, 2 hooks
TSR4	Removable IV pole, 2-stage, 4 hooks
CROBPT	Foldable push bars head-end
CROBPP1	Foldable push bar foot-end 1 part
CROK7	X-ray cassette below the patient surface (double hard surface) (incompatible with CORBE + CRORJ + CORJE)
CORBE	Electric backrest with manual release
CORJE	Electric backrest and knee gatch, manual release
COBBA	Battery
COTLC	Patient's remote control
CRORJ	Knee gatch
CROSO2	Oxygen bottle holder
CROSP	Paper roll dispenser at the head-end
CRODOC	Chart holder (for paperwork) below the headrest
PSU	Attachment hooks for bags on both sides below the patient surface
CROPSC	Monitor tray at the foot-end. 2 locations available (1 tray in width 60 cm / 1 or 2 trays in width 70 and 80 cm)
MMM	High Comfort mattress, high quality foam (35 kg/m ³) + 2 cm thick viscoelastic layer (total height : 12 cm)
EQUI	Equipotential connection
CRORT	Rail DIN
ETU	Fixation clamp for armrest (on rail DIN, CRORT necessary)
ETU-R	Adjustable fixation clamp for armrest (on rail DIN, CRORT necessary)
GT	Anatomic shaped armrest (ETU-R necessary)
CROPB	Side rail padded cushions (pair)
PRU	Universal Meal tray Extensible meal tray for side rails: from 65 to 88 cm Fall protection side

ACCESSORIES

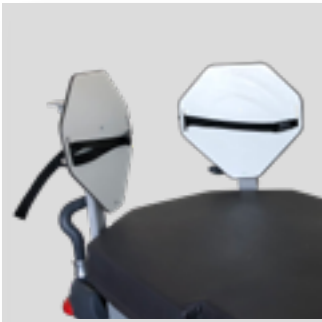

Monitor tray at the foot-end
CROPSC



High Comfort mattress, high quality foam (35kg/m³), 2cm thick viscoelastic layer (total thickness : 12cm)
MMM



Side rail padded cushions (pair)
CROPB



Universal Meal tray
Extensible meal tray for side rails: from 65 to 88 cm
Fall protection side
Compatible with standardized tray meal :
GastroNorm – GN1/1 : 53 x 32.5 cm
EuroNorm : 53 x 37 cm
It fits with all width of products.
Maximum load: 10Kg
PRU





STRETCHER TROLLEY I-CARE EMERGENCY

I-CARE is a patient trolley with height adjustment on hydraulic columns.

Stable and robust, it is ideally designed to an intensive use.

Its features and its wide range of accessories make it especially suitable for Emergency, OR, PACU or ASC settings.

Comfortable

Adaptable many options available

Easy to use, variable height & trendelenburg

Versatile, adapted to different hospital services



I-CARE EMERGENCY

I-CARE EMERGENCY DIMENSIONS

	LENGTH	WIDTH
OVERALL	216 cm	74 / 84 cm
VARIABLE HEIGHT	68 - 101 cm (with 10 cm thick mattress)	

PRODUCT WEIGHT : 80 Kg
SAFE WORKING LOAD : 320 Kg

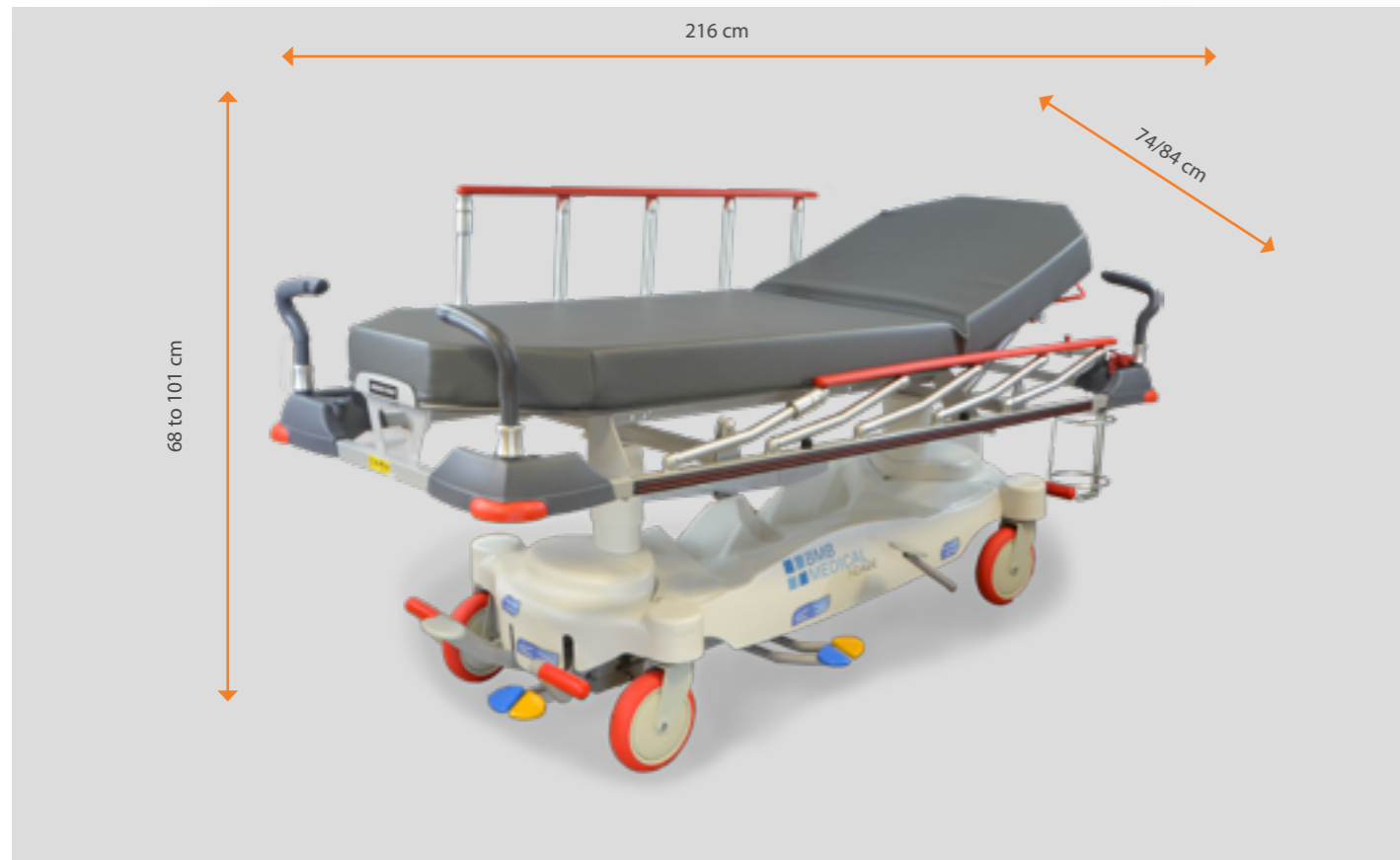

NON CONTRACTUAL PHOTOS - ACCESSORIZED PRODUCTS

Combining lightness, robustness and intuitiveness, our STRETCHER TROLLEY range is suitable for patient transfer, emergencies and recovery room. On request, many options allow a perfect match to your needs.

Height-adjustable stretcher trolley

- Height adjustment range : from 58 to 91 cm (without 10 cm thick mattress)
- Trendelenburg / Anti-Trendelenburg +/- 18°
- Backrest adjustable by 2 gas springs (0 - 90°)
- Removable mattress made of high quality and resilience foam (35kg/m³) - Thickness : 10 cm
- Radiolucent material
- Two-sided + foot or head-end height adjustment and Trendelenburg / Anti-Trendelenburg adjustment
- 6 holders for IV pole
- Bumpers on all 4 corners
- Castors with central braking system Ø 200 mm at foot- and head-end
- 5th retractable directional wheel
- Drop-down side rails with 5 vertical bars - Anodized aluminium
- Foldable push bars at the foot-end 2 parts
- Frame cover (removable for easy cleaning and maintenance) including utility tray and O2 tank holder
- Removable cover - PVC coated Jersey - Colour : grey

6 holders for IV pole



Removable mattress made of high quality and resilience foam (35kg/m³), thickness: 10 cm

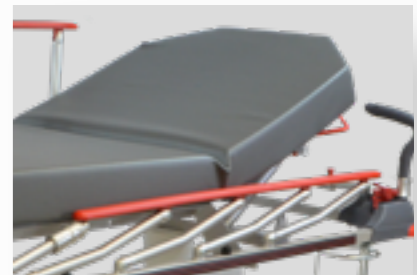

Castors with central braking system Ø 200 mm at foot- and head-end



Foldable push bars at the foot-end 2 parts

Frame cover (removable for easy cleaning and maintenance) including utility tray and O2 tank holder



Two-sided + foot or head-end height adjustment and Trendelenburg / Anti-Trendelenburg adjustment

ACCESSORIES



Anti-static system
CLORA

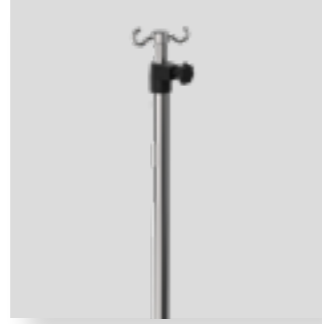

Removable IV pole, 2-stage, 2 hooks
TSR2



Foldable push bars head-end
CROBPT



Foldable push bar foot-end 1 part
CROBPP1



X-ray cassette below the patient surface
(incompatible with CORBE + CRORJ + CORJE)
CROK7



Electric backrest with manual release
CORBE



Knee gatch & Electric backrest and
knee gatch, manual release
CRORJ & CORJE



Patient's remote control
COTLC

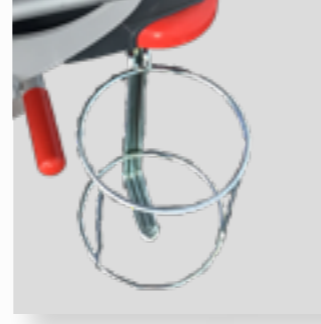

Vertical oxygen bottle holder
CROSO2



Paper roll dispenser at the head-end
CROSP



Chart holder (for paperwork)
below the headrest
CRODOC



Attachment hooks for bags on both
sides below the patient surface
PSU

REFERENCE	DESIGNATION
CLORA	Anti-static system
TSE2C	Permanent, foldable 3-stage "comfort" IV pole, 2 hooks
TSE4C	Permanent, foldable 3-stage "comfort" IV pole, 4 hooks
TSR2	Removable 2-stage IV pole, 2 hooks
TSR4	Removable IV pole, 2-stage, 4 hooks
CROBPT	Foldable push bars head-end
CROBPP1	Foldable push bar foot-end 1 part
CROK7	X-ray cassette below the patient surface (double hard surface) (incompatible avec CORBE + CRORJ + CORJE)
CORBE	Electric backrest with manual release
CORJE	Electric backrest and knee gatch, manual release
COBBA	Battery
COTLC	Patient's remote control
CRORJ	Knee gatch
CRORT	Rail DIN
ETU	Fixation clamp for armrest (on rail DIN, CRORT necessary)
ETU-R	Adjustable fixation clamp for armrest (on rail DIN, CRORT necessary)
GT	Anatomic shaped armrest (ETU-R necessary)
CROSO2	Vertical oxygen bottle holder
CROSP	Paper roll dispenser at the head-end
CRODOC	Chart holder (for paperwork) below the headrest
PSU	Attachment hooks for bags on both sides below the patient surface
CROPSC	Monitor tray at the foot-end. 2 locations available (1 tray in width 60cm / 1 or 2 trays in width 70 cm)
MMM	High Comfort mattress, high quality foam (35 kg/m ³) + 2 cm thick viscoelastic layer (total height : 12 cm)
EQUI	Equipotential connection
CROPB	Side rail padded cushions (pair)
PRU	Universal Meal tray Extensible meal tray for side rails: from 65 to 88 cm Fall protection side



STRETCHER TROLLEY I-CARE OPHTHALMOLOGY

Comfortable

Adaptable numerous options available

Easy to use, variable height & trendelenburg

Versatile, adapted to different hospital services

I-CARE is a patient trolley with height adjustment on hydraulic columns.

With its removable surgery headrests, the product is adapted to one day surgery.

I-CARE OPHT is for ophthalmic surgery, Stomatology, ENT, hand surgery...



I-CARE OPHTHALMOLOGY

I-CARE OPHTHALMOLOGY DIMENSIONS

	LENGTH	WIDTH
OVERALL	201 cm / 235 cm (with headrest)	84 cm
VARIABLE HEIGHT	66-99 cm (with 8 cm thick mattress)	

PRODUCT WEIGHT : 90 Kg
SAFE WORKING LOAD : 200 Kg

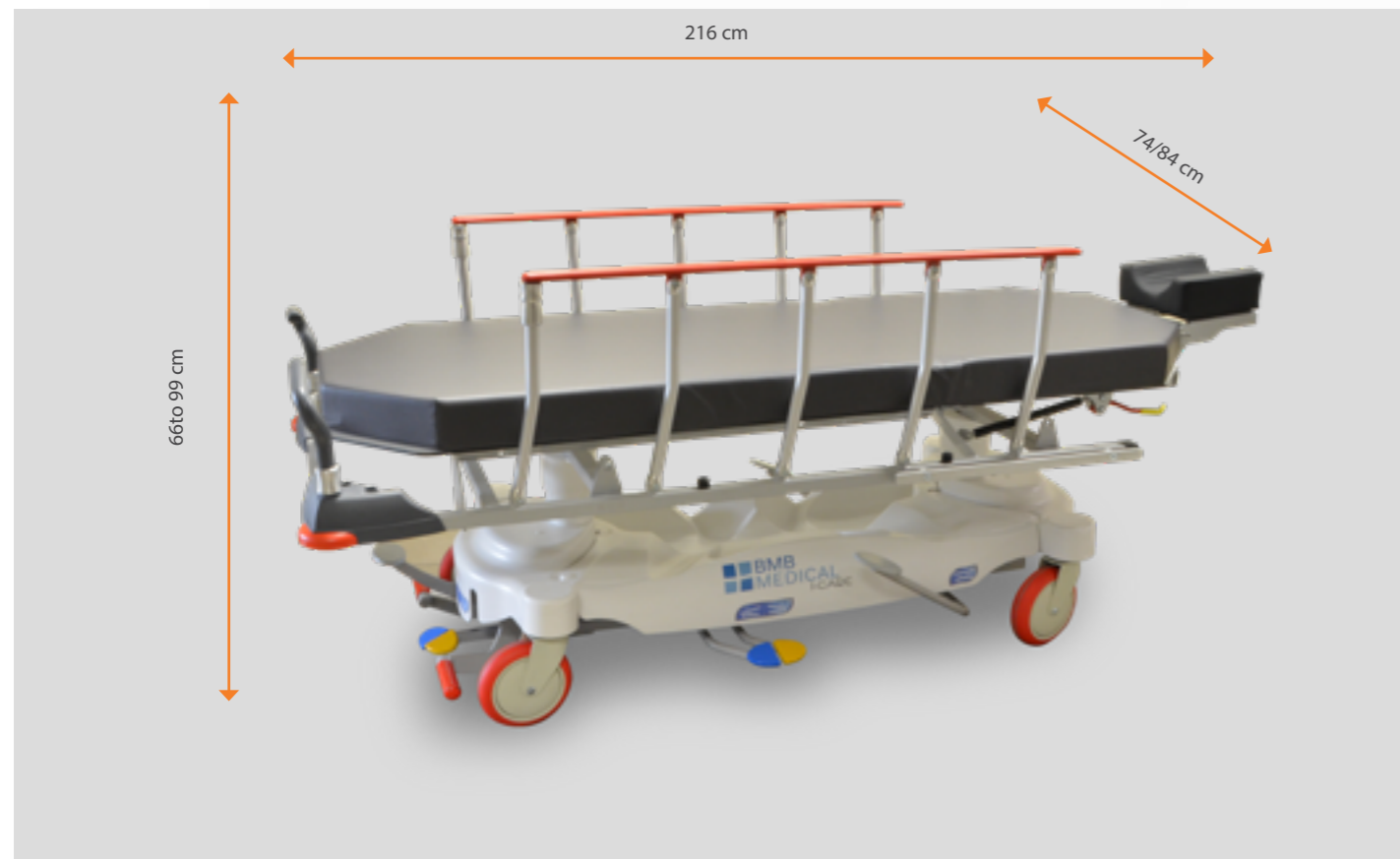

NON CONTRACTUAL PHOTOS - ACCESSORIZED PRODUCTS

Combining lightness, robustness and intuitiveness, our STRETCHER TROLLEY range is suitable for patient transfer, emergencies and recovery room.

On request, many options allow a perfect match to your needs.

Height-adjustable stretcher trolley

- Height adjustment range: from 58 to 91 cm (without 8 cm thick mattress)
- Trendelenburg / Anti-Trendelenburg +/-18°
- Backrest adjustable by 2 gas springs (0 - 70°)
- Removable mattress made of high quality and resilience foam (35kg/m³) - Thickness : 8 cm
- Radiolucent material
- Bilateral foot-operated variable height control / Trendelenburg / brakes
- Castors with central braking system Ø 200 mm at foot-end and head-end
- 5th retractable directional wheel
- Drop-down side rails with 5 vertical bars - Anodized aluminium
- Foldable push bars at the foot-end 2 parts
- DIN rails
- Frame cover including utility tray and O2 tank holder
- Removable cover - PVC coated Jersey - Colour : grey

5th retractable directional wheel

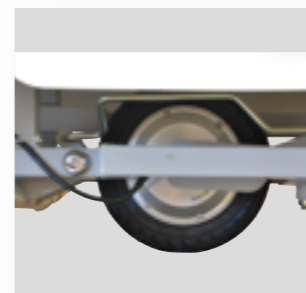

Removable mattress made of high quality and resilience foam (35kg/m³), thickness : 8 cm

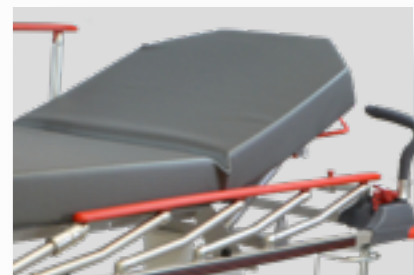

Castors with central braking system Ø 200 mm at foot-end and head-end



Foldable push bars at the foot-end 2 parts

Frame cover including utility tray and O2 tank holder



Bilateral foot-operated variable-height and trendelenburg foot control

ACCESSORIES



Anti-static system
CLORA



Articulated removable surgery
head rest for ophthalmology + hollow cushion
LCA-OPH

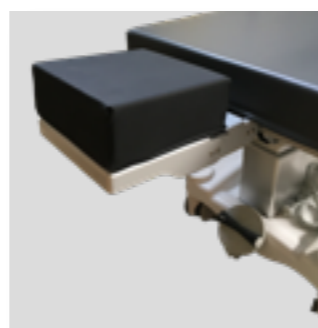

Articulated removable surgery
head rest for stomatology + flat cushion
LCA-PLA

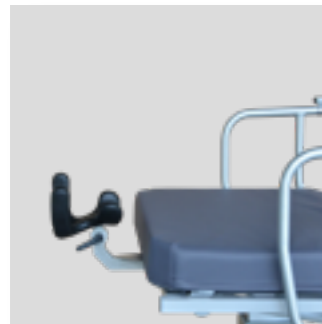

Removable surgery head rest for
stomatology and ENT
LCA-STO



Additional hollow cushion for articulated
removable surgery headrest
LCA-CC

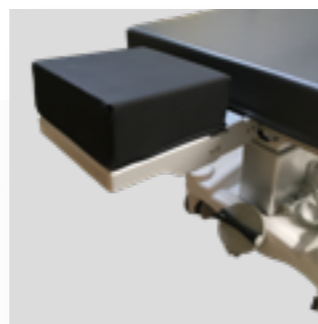

Additional flat cushion for
articulated removable surgery headrest
LCA-CP

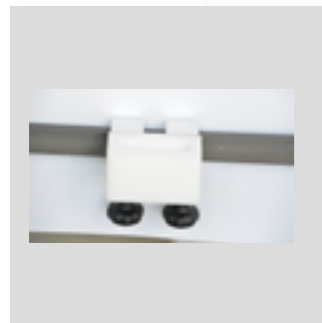

Head rest support. Fixation
on technical rails
LCA-SUP

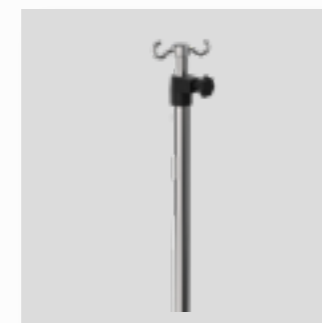

Removable IV pole, 2-stage, 2 hooks
TSR2



Holder for operating field, with
connection for oxygen
FSC



Foldable push bar
foot-end 1 part
CROBPP1



Knee gatch
CRORJ



Side rail padded
cushions (pair)
CROPB

REFERENCE	DESIGNATION
CLORA	Antistatic system
LCA-OPH	Articulated removable surgery head rest for ophthalmology + hollow cushion
LCA-PLA	Articulated removable surgery head rest for stomatology + flat cushion
LCA-STO	Removable surgery head rest for stomatology and ENT
LCA-CC	Additional hollow cushion for articulated removable surgery headrest
LCA-CP	Additional flat cushion for articulated removable surgery headrest
LCA-SUP	Head rest support. Fixation on technical rails.
TSR2	Removable 2-stage IV pole, 2 hooks
TSR4	Removable IV pole, 2-stage, 4 hooks
ETU	Fixation clamp for armrest (on rail DIN, CRORT necessary)
ETU-R	Adjustable fixation clamp for armrest (on rail DIN, CRORT necessary)
GT	Anatomic shaped armrest (ETU-R necessary)
FSC	Holder for operating field, with connection for oxygen
CROBPP1	Foldable push bar foot-end 1 part
CRORJ	Knee gatch
EQUI	Equipotential connection
CROPB	Side rail padded cushions (pair)
PRU	Universal Meal tray Extensible meal tray for side rails: from 65 to 88 cm Fall protection side



Universal Meal tray
Extensible meal tray for side rails:
from 65 to 88 cm
Fall protection side
Compatible with standardized tray meal :
GastroNorm – GN1/1 : 53 x 32.5 cm
EuroNorm : 53 x 37 cm
It fits with all width of products.
Maximum load: 10Kg
PRU



MOTORISED I-CARE U EZ-GO EMERGENCY

Comfortable for the patient and staff

Adaptable many options available

Easy to use, motorized wheel, throttle grip.

Versatile, supplied with two batteries and an external charger

I-CARE U EZ-GO is a motorized patient trolley. It is equipped with fifth autonomous motorized wheel, two batteries and an external charger.

Its autonomy is 5 km per battery with a 5-hour recharge.



I-CARE U EZ-GO EMERGENCY

I-CARE U EZ-GO EMERGENCY DIMENSIONS

	LENGTH	WIDTH
OVERALL	221 cm	84 / 94 cm
VARIABLE HEIGHT	66-99 cm (including mattress)	

PRODUCT WEIGHT : 92 Kg / 97 Kg (depending on model)
SAFE WORKING LOAD : 320 Kg



NON CONTRACTUAL PHOTOS - ACCESSORIZED PRODUCTS

Combining lightness, robustness and intuitiveness, our STRETCHER TROLLEY range is suitable for patient transfer, emergencies and recovery room. On request, many options allow a perfect match to your needs.

Motorized stretcher

- Height adjustment range : from 58 to 91 cm (without 8 cm thick mattress)
- Trendelenburg / Anti-Trendelenburg +/- 18°
- Backrest adjustable by 2 gas springs (0 - 90°)
- Removable mattress high resilience foam (35kg/m3) - Thickness : 8 cm
- Motorized drive system with autonomous wheel
- Switchable battery - 5 km autonomy per battery - Charge time: 5 hours
- Lithium battery without memory effect
- Supplied with two batteries and an external charger
- Throttle grip with progressive speed acceleration (foot-end)
- Radiolucent material
- Two-sided head-end height adjustment and Trendelenburg / Anti-Trendelenburg adjustment
- Fixed push bar foot-end
- Head-side retractable push bars
- 6 holders for IV pole
- Bumpers on all 4 corners
- Castors with central braking system Ø 200 mm at foot
- 5th retractable and directional wheel (motorized wheel)
- Antistatic system
- Drop-down side rails with 5 vertical bars - Anodized aluminium
- Frame cover (removable for easy cleaning and maintenance) including utility tray and O2 tank holder
- Removable cover - PVC coated Jersey - Colour : grey

6 holders for IV pole



Batteries rechargeable by external charger



Throttle grip with progressive speed acceleration (foot-end)



Push bars foot-end



Motorized drive system with autonomous wheel



Two-sided head-end height adjustment and Trendelenburg / Anti-Trendelenburg adjustment

ACCESSORIES



Removable 2-stage IV pole, 2 hooks
TSR2



Universal Meal tray
PRU



Electric backrest with
manual release
CORBE



Knee gatch & Electric backrest
and knee gatch, manual release
CRORJ & CORJE



Additional battery
EZOBA



Vertical oxygen bottle holder
CROSO2



Paper roll dispenser at the head-end
CROSP



Chart holder (for paperwork)
below the headrest
CRODOC



Attachment hooks for bags on both sides
below the patient surface
PSU

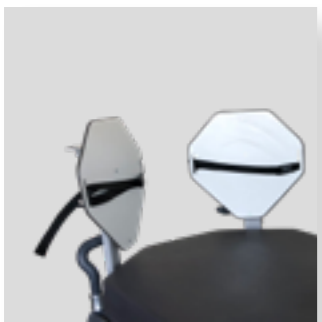

Monitor tray at the foot-end
CROPSC



High Comfort mattress
MMM



Side rail padded cushions (pair)
CROPB

REFERENCE	DESIGNATION
TSE2C	Permanent, foldable 3-stage "comfort" IV pole, 2 hooks
TSE4C	Permanent, foldable 3-stage "comfort" IV pole, 4 hooks
TSR2	Removable 2-stage IV pole, 2 hooks
TSR4	Removable IV pole, 2-stage, 4 hooks
CROK7	X-ray cassette below the patient surface (incompatible with CORBE + CRORJ + CORJE)
CORBE	Electric backrest with manual release
CROSO2	Vertical oxygen bottle holder
CROSP	Paper roll dispenser at the head-end
CRODOC	Chart holder (for paperwork) below the headrest
CORJE	Electric backrest and knee gatch, manual release
COBBA	Battery for CORBE and CORJE
CRORJ	Knee gatch
EZSBA	Without battery (depreciation)
EZOBA	Additional battery
EZOCH	External wall charger
EZOPO	External charger mobile version
EZOS1	Charging station 1 charger
EZOS2	Charging station 2 chargers (one multi-socket included)
EZOS3	Charging station with 3 chargers (one multi-socket included)
EZOS4	Charging station with 4 chargers (one multi-socket included)
PSU	Attachment hooks for bags on both sides below the patient surface
CROPSC	Monitor tray at the foot-end.
MC	Comfort mattress, high quality foam (35kg/m3), height : 10cm
MMC	High Comfort mattress, high quality foam (35kg/m3), 2 cm thick viscoelastic layer (total height : 12 cm)
MCU	High comfort mattress, high resilience foam (35kg/m3) long lasting comfort - anti-bedsore properties - total thickness 15cm
EQUI	Equipotential connection

REFERENCE	DESIGNATION
CRORT	DIN rails
ETU	Fixation clamp for armrest (on technical rails, CRORT necessary)
ETU-R	Adjustable fixation clamp for armrest (on technical rails, CRORT necessary)
GT	Anatomic shaped armrest (ETU-R necessary)
CROPB	Side rail padded cushions (pair)
PRU	Universal Meal tray Extensible meal tray for side rails: from 65 to 88 cm Fall protection side



Additional battery
EZOBA



External wall charger
EZOCH



External charger mobile version
EZOPO



Charging station 1 charger
EZOS1



Charging station 2/3/4 chargers
(one multi-socket included)
EZOS2 - EZOS3 - EZOS4





MOTORISED I-CARE U EZ-GO AMBULATORY

I-CARE U EZ-GO is a motorized patient trolley. It is equipped with fifth autonomous motorized wheel, two batteries and an external charger.

Its autonomy is 5 km per battery with a 5-hour recharge.

Comfortable for the patient and staff

Adaptable many options available

Easy to use, motorized wheel, throttle grip.

Versatile, supplied with two batteries and an external charger



I-CARE U EZ-GO AMBULATORY

I-CARE U EZ-GO AMBULATORY DIMENSIONS

	LENGTH	WIDTH
OVERALL	221 cm	78 / 88 cm
VARIABLE HEIGHT	66 - 99 cm (including mattress)	

PRODUCT WEIGHT : 102 Kg / 107 Kg (depending on model)
SAFE WORKING LOAD : 320 Kg

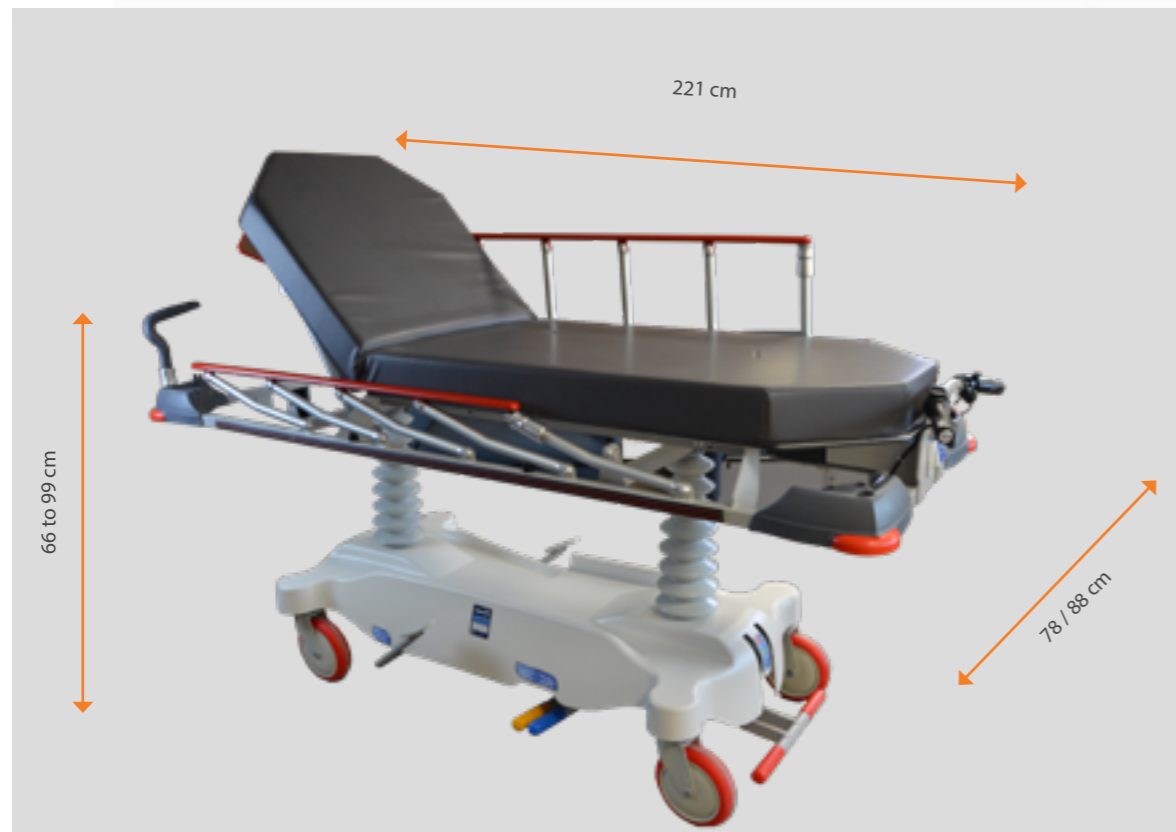

NON CONTRACTUAL PHOTOS - ACCESSORIZED PRODUCTS

Combining lightness, robustness and intuitiveness, our STRETCHER TROLLEY range is suitable for patient transfer, emergencies and recovery room. On request, many options allow a perfect match to your needs.

Motorized stretcher

- Overall dimensions: 78 x 221 cm or 88 x 221 cm (depending on model)
- Height adjustment range : from 58 to 91 cm (with 8 cm thick mattress)
- Trendelenburg / Anti-Trendelenburg +/- 18°
- Backrest adjustable by 2 gas springs (0 - 90°)
- Removable mattress high resilience foam (35kg/m3) - Thickness : 8 cm
- Motorized drive system with autonomous wheel.
- Switchable battery - 5 km autonomy per battery - Charge time: 5 hours
- Lithium battery without memory effect
- Supplied with two batteries and an external charger
- Throttle grip with progressive speed acceleration (foot-end)
- Radiolucent material
- Two-sided head-end height adjustment and Trendelenburg / Anti-Trendelenburg adjustment
- Fixed push bar foot-end
- Head-side retractable push bars
- 6 holders for IV pole
- Bumpers on all 4 corners
- Castors with central braking system Ø 200 mm at foot
- 5th retractable and directional wheel (motorized wheel)
- Antistatic system
- Drop-down side rails with 3 horizontal bars - Anodized aluminium
- Frame cover (removable for easy cleaning and maintenance) including utility tray and O2 tank holder
- Removable cover - PVC coated Jersey - Colour : grey

6 holders for IV pole

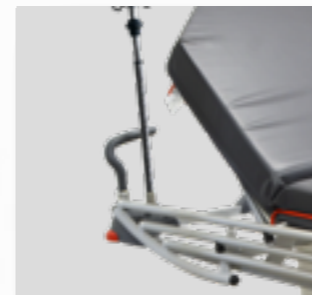

Batteries rechargeable by external charger

Throttle grip with progressive speed acceleration (foot-en)



2 fixed push bar foot-end.

Motorized drive system with autonomous wheel

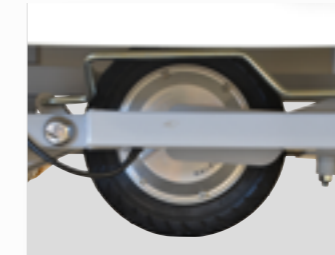

Two-sided head-end height adjustment and Trendelenburg / Anti-Trendelenburg adjustment

ACCESSORIES



Removable 2-stage IV pole, 2 hooks
TSR2



Universal Meal tray
PRU



Electric backrest with
manual release
CORBE



Knee gatch & Electric backrest
and knee gatch, manual release
CRORJ & CORJE



Additional battery
EZOPA



Vertical oxygen bottle holder
CROSO2

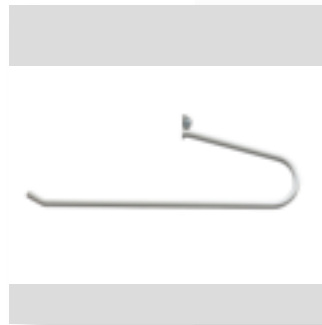

Paper roll dispenser
at the head-end
CROSP



Chart holder below the
headrest
CRDOC



Attachment hooks for bags on both
sides below the patient surface
PSU



Monitor tray at the foot-
end.
CROPSC



High Comfort mattress
MMM

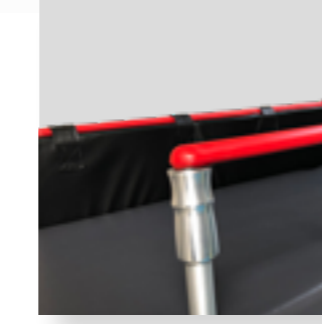

Side rail padded
cushions (pair)
CROPB

REFERENCE	DESIGNATION
TSE2C	Permanent, foldable 3-stage "comfort" IV pole, 2 hooks
TSE4C	Permanent, foldable 3-stage "comfort" IV pole, 4 hooks
TSR2	Removable 2-stage IV pole, 2 hooks
TSR4	Removable IV pole, 2-stage, 4 hooks
CROK7	X-ray cassette below the patient surface (incompatible with CORBE + CRORJ + CORJE)
CORBE	Electric backrest with manual release
CROSO2	Vertical oxygen bottle holder
CROSP	Paper roll dispenser at the head-end
CRDOC	Chart holder (for paperwork) below the headrest
CORJE	Electric backrest and knee gatch, manual release
COBBA	Battery for CORBE and CORJE
CRORJ	Knee gatch
EZSBA	Without battery (depreciation)
EZOPA	Additional battery
EZOCH	External wall charger
EZOPO	External charger mobile version
EZOS1	Charging station 1 charger
EZOS2	Charging station 2 chargers (one multi-socket included)
EZOS3	Charging station with 3 chargers (one multi-socket included)
EZOS4	Charging station with 4 chargers (one multi-socket included)
PSU	Attachment hooks for bags on both sides below the patient surface
CROPSC	Monitor tray at the foot-end. 2 locations available (1 tray in width 60 cm / 1 or 2 trays in width 70 and 80 cm)
MC	Comfort mattress, high quality foam (35kg/m ³), height : 10cm
MMC	High Comfort mattress, high quality foam (35kg/m ³), 2 cm thick viscoelastic layer (total height : 12 cm)
MCU	High comfort mattress, high resilience foam (35kg/m ³) long lasting comfort - anti-bedsore properties - total thickness 15cm
EQUI	Equipotential connection
CRORT	DIN rails

REFERENCE	DESIGNATION
CRORT	DIN rails
ETU	Fixation clamp for armrest (on technical rails, CRORT necessary)
ETU-R	Adjustable fixation clamp for armrest (on technical rails, CRORT necessary)
GT	Anatomic shaped armrest (ETU-R necessary)
CROPB	Side rail padded cushions (pair)
PRU	Universal Meal tray Extensible meal tray for side rails: from 65 to 88 cm Fall protection side



Additional battery
EZOBA



External wall charger
EZOCH



External charger mobile version
EZOPO



Charging station 1 charger
EZOS1



Charging station 2/3/4 chargers
(one multi-socket included)
EZOS2 - EZOS3 - EZOS4





FIXED-HEIGHT STRETCHER TROLLEY PRELE

Easy to use

Adaptable many options available

Versatile, adapted to different hospital services

PRELE is a stretcher with fixed height.

Extremely light and easy to steer, it is intended for the patient transportation service.

Equipped with an assisted back-rest and with a directional blocking caster, PRELE establishes a basic item of the patient transfer which don't sacrifice at all the comfort of the nursing staff.

PRELE

PRELE DIMENSIONS

	LENGHT	WIDTH	HEIGHT
OVERALL	201 cm	74 cm	88 cm (with mattress)

PRODUCT WEIGHT : 50 Kg
SAFE WORKING LOAD : 200 Kg



NON CONTRACTUAL PHOTOS - ACCESSORIZED PRODUCTS

Combining lightness, robustness and intuitiveness, our STRETCHER TROLLEY range is suitable for patient transfer, emergencies and recovery room.

On request, many options allow a perfect match to your needs.

Stretcher with fixed height

- Fixed height
- 2-sectional resin mattress base: 60 x 190 cm
- Thermoformed ABS base
- Removable mattress made of high quality and resilience foam (35kg/m³) - Thickness : 8 cm
- 2 holders for IV pole
- Bumpers on all 4 corners
- Backrest adjustable by 2 gas springs (0 - 90°)
- 4 lockable castors Ø 150 mm
- 1 caster with directional lock
- Drop-down side rails with 2 horizontal bars - Anodized aluminium
- Push bars at the foot-end
- Basket for accessory
- Removable cover - PVC coated Jersey - Colour : grey

2 holders for IV pole



Removable mattress made of high quality and resilience foam (35kg/m³), height : 8 cm

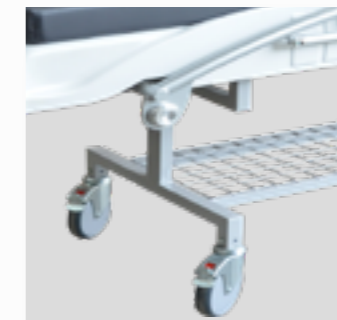
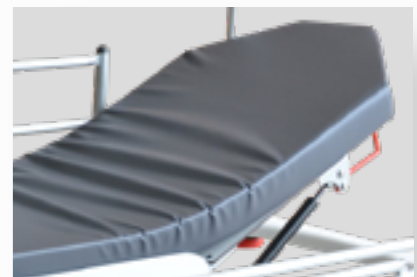

4 lockable castors Ø 150 mm



Drop-down side rails, 2 horizontal bars. Anodized aluminium



Bumpers on all 4 corners

ACCESSORIES

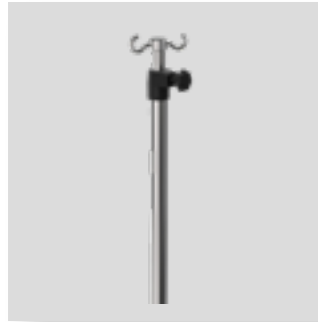

Removable IV pole, 2-stage, 2 hooks
TSR2



Foldable push bars foot-end
BPP



Foldable push bars head-end



Paper roll dispenser at the head-end
CROSP



Chart holder (for paperwork) below the headrest
CRODOC



Attachment hooks for bags on both sides below the patient surface
PSU

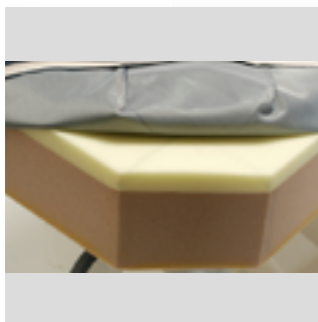

Comfort mattress
CEOMM



Vertical oxygen bottle holder
CROSO2



Universal Meal tray
PRU

REFERENCE	DESIGNATION
TSR2	Removable IV pole, 2-stage, 2 hooks
TSR4	Removable IV pole, 2 stage, 4 hooks
BPP	Foldable push bars foot-end
BPT	Foldable push bars head-end
CROSP	Paper roll dispenser at the head-end
CRODOC	Chart holder (for paperwork) below the headrest
PSU	Attachment hooks for bags on both sides below the patient surface
CROSO2	Vertical oxygen bottle holder
PRU	Universal Meal tray Extensible meal tray for side rails: from 65 to 88 cm Fall protection side
CEOMM	Comfort mattress

A medical professional must always rely on his or her own professional clinical judgment when deciding whether to use a product(s) when treating a particular patient.

A healthcare professional anyway, refers to the package insert, product label and/or instructions for use before using any BMB MEDICAL product.

The products depicted are CE marked in accordance with EU Regulations and Directives.

The products are Class 1 Medical Devices.



Tél : +33 (0)4 74 08 71 71
Fax : +33 (0)4 74 08 71 72
info@bmb-medical.com

100 Av. du Formans - CS 11001
01604 TREVOUX Cedex
FRANCE

www.bmb-medical.com